

BB-46U5DS

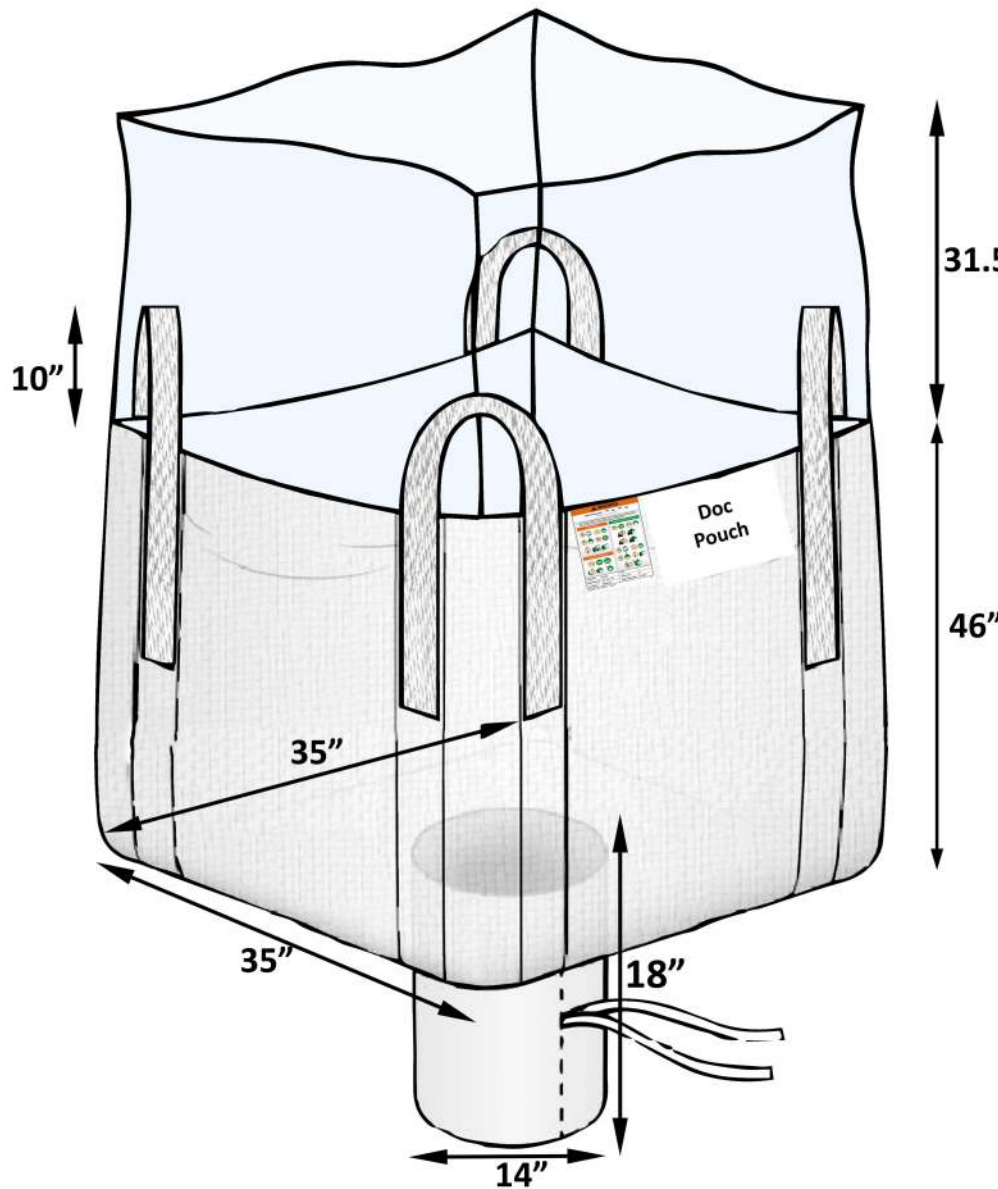

Specification

Bag Dimension:	35x35x46"
SWL/SF:	2200lbs / 5:1
Bag construction:	Circular
Body Fabric:	4.7oz (160gsm) Uncoated White fabric
Duffle Top:	31.5" long
Duffle Fabric:	1.90 + 0.59oz (65+20gsm) coated
Duffle tie:	Flat PP tie tape
Bottom Spout:	diameter 14 x 18" long
Bottom Spout Fabric:	2.65 + 0.59oz (90+20gsm) coated
Bottom Spout tie:	Flat PP tie tape
Bottom Closure:	Star closure
Bottom Closure tie:	Flat PP tie tape
Lifting Loops:	4 Corner loops x 10" free height x 2.36" width
Material:	PP Webbing / White Color
Sift proof seams:	No
Document pouch:	Standard
Seams:	Double Chain - White/Blue
Packing:	Bales of 50, strapped to pallets. 255/Pallet.
Pallet type:	40"x48"x53"(H); Gross Wt./Pallet< 1,000 lbs.
Raw Material:	FDA Compliant, 100% Virgin Polypropylene