

BB-52CSS

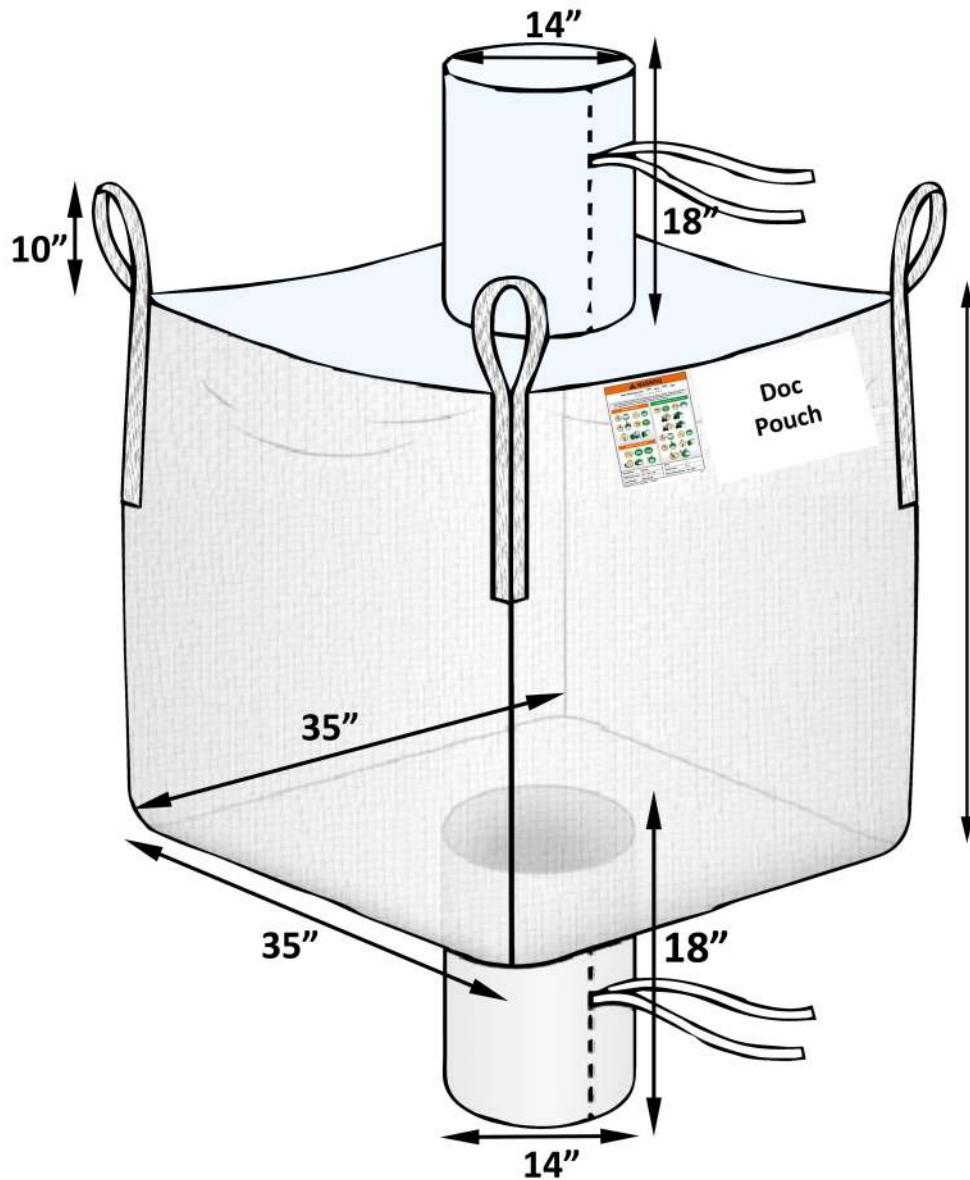

Specification

Bag Dimension:	35x35x52"
SWL/SF:	3000lbs / 5:1
Bag construction:	U-Panel
Body Fabric:	5+0.88oz (170+30gsm) Coated White fabric
Top Fabric:	1.90 + 0.59oz (65+20gsm) coated
Top Spout:	diameter 14 x 18" long
Top Spout Fabric:	1.90 + 0.59oz (65+20gsm) coated
Top Spout tie:	Flat PP tie tape
Bottom Spout:	diameter 14 x 18" long
Bottom Spout Fabric:	2.4 + 0.59oz (80+20gsm) coated
Bottom Spout tie:	Flat PP tie tape
Bottom Closure:	Star closure
Bottom Closure tie:	Flat PP tie tape
Lifting Loops:	4 corner loops x 10" free height x 2" width
Material:	PP Webbing / White Color
Sift proof seams:	Double sides
Document pouch:	Standard pouch
Seams:	Double Chain - White/Blue
Packing:	Bales of 50, strapped to pallets. 200/Pallet.
Pallet type:	40"x48"x53"(H); Gross Wt./Pallet< 1,000 lbs.
Raw Material:	FDA Compliant, 100% Virgin Polypropylene